

Load value table

General information regarding hinge load values

Reference value 160 kg, single-axis hinges

Overview of the load value table

The following table provides you an overview of the maximum load value for the individual hinge type, taking the interaction of width and height of the door as well as the hinge gap into account.

Assuming a reference value with door leaf dimensions of 1000 x 2000 mm (W x H), the use of 2 hinges and a hinge gap of 1450 mm, the permissible load values change with different width and height ratios..

The specifications below are guidelines, especially in the case of borderline load requirements. For further information or advice please contact us.

Load value table 160 kg, single-axis hinges

Green: load value = reference value. **Orange:** load value < reference value.



single-axis hinges

Hinge gap in mm	Door height in mm*	* i Hinge positioning 250 mm from the top and the bottom of the door leaf								
2000	2500	160	160	160	156	152	148	144	140	136
1950	2450	160	160	160	156	152	148	144	140	136
1900	2400	160	160	160	156	152	148	144	140	136
1850	2350	160	160	160	156	152	148	144	140	135
1800	2300	160	160	160	156	152	148	144	140	131
1750	2250	160	160	160	156	152	148	144	137	128
1700	2200	160	160	160	156	152	148	142	133	124
1650	2150	160	160	160	156	152	148	138	129	121
1600	2100	160	160	160	156	152	143	134	125	-
1550	2050	160	160	160	156	149	139	130	-	-
1500	2000	160	160	160	155	144	134	125	-	-
1450	1950	160	160	160	148	138	-	-	-	-
		900	950	1000	1050	1100	1150	1200	1250	1300

→ Door width in mm

Load values for hinges

An accurate, professional fitting in accordance with the SIMONSWERK installation instructions is always a prerequisite:

-) Installation site (residential building, public building, school, administration, barracks, kindergarten etc.)
-) Type of material of the element
-) Frequency of operation
-) Door dimensions (e.g. excess widths)
-) Positioning of hinges
-) Assembly of hinges
-) Outward opening doors (porch)
-) Door stop
-) Door closer
-) Swing-door operator
-) Wall soffits
-) Closing sequence control systems, etc.

1. Basics

When selecting or deciding on a hinge, the load alone is already often viewed as being identical to the weight of the door. However, the hinge load can often be several times the door weight, caused by various influential factors.

Even taking these various criteria into account, an additional reserve should always still be included when selecting the hinge.

Especially in public buildings where extra loads are incurred due to the high opening frequency and stress which is not always calculable (kindergarten, hospitals etc.), sufficiently dimensioned hinges should be used even if this would not have been necessary merely based on the door weight as such.

An accurate, professional fitting in accordance with the SIMONSWERK installation instructions is always a prerequisite.

Reference details

The load specifications for SIMONSWERK hinges are based on a maximum door weight. Additionally, the named influential factors must be taken into account for hinge loads.

All indications are based on the following references:

Door leaf dimensions	1000 x 2000 mm
Use of	2 hinges
Hinge distance	1450 mm

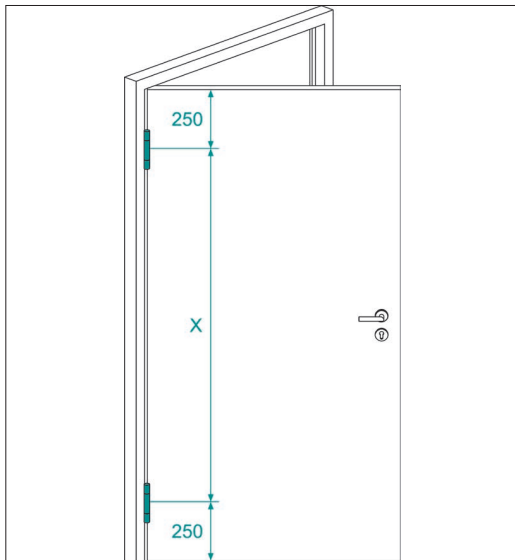

2. Hinge positioning

SIMONSWERK recommends the tried-and-tested hinge positioning as shown in the image. In the case of increased loads, SIMONSWERK recommends a hinge in the upper third (see „4. Third hinge“).

Load values for hinges

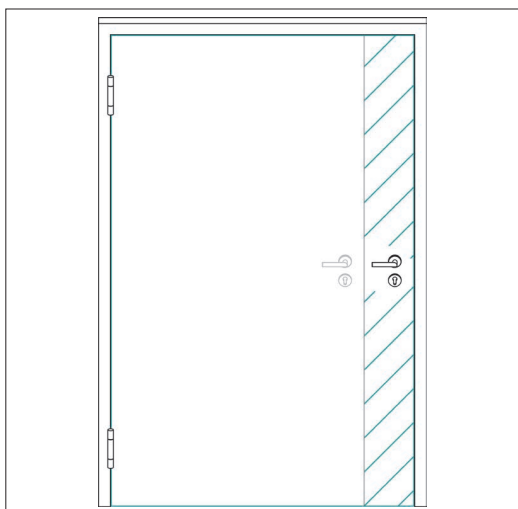

3. Doors with excess widths

SIMONSWERK heavy-duty hinges have generally been designed for the indicated load capacities. Please note that the load values are already reduced from a door width of 100 cm, with the hinge spacing remaining the same.

Detailed information can be found in the "Load value table" on page 1.

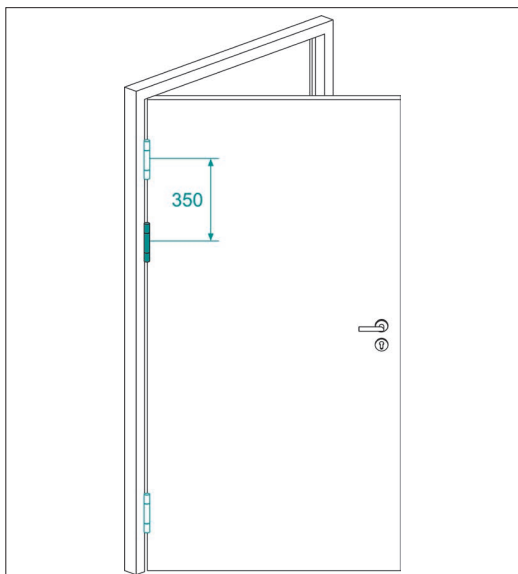

4. Third hinge

In addition to the factors mentioned above the use of a third hinge can have a significant impact on the load capacity. In practice often a third hinge is located in the middle of the door in order to meet the optical demands and to minimise warping in the centre of the door. Under certain circumstances however it may be useful or even necessary to additionally support the upper hinge which takes most of the major tractive forces - this could be true, for instance, in the case of extra-wide doors (>1000 mm), where additional forces occur due to the lever action. For these applications the third hinge has to be located in the upper third since only then the load capacity of the hinge is positively influenced. SIMONSWERK recommends reducing the specified spacing of 350 mm to the dimension of 250 mm, depending on the knuckle length. A third hinge does not necessarily lead to an increase in the specified load value.

It has a supporting effect in case of additional stress that occurs, e.g. when a door closer is used or in case of high frequency of use, etc.

Load values for hinges

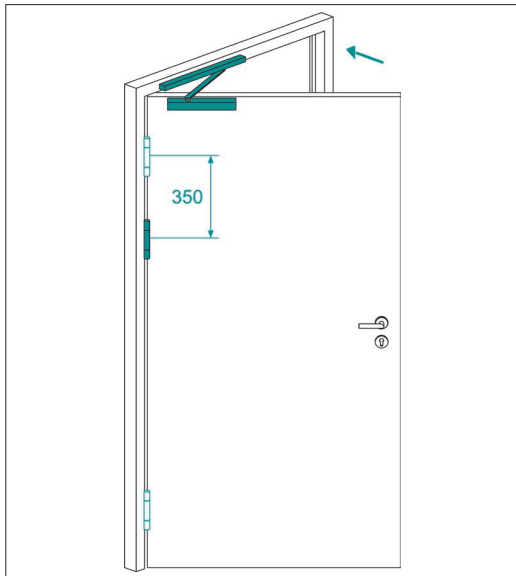

5. Door closers

When overhead door closers are used, SIMONSWERK recommends the use of a third hinge in the upper third of the door (see "4. Third hinge"). The correct adjustment of the closer is a fundamental requirement for a long-lasting, problem-free functioning.

The use of door closing systems mounted laterally in the rebate is not recommended due to the unfavourable angle of rotation and the resulting impact of force.

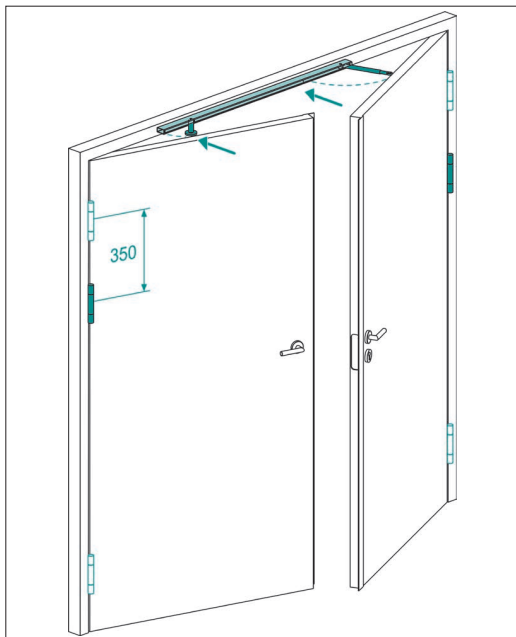

6. Closing sequence control systems

When closing sequence control systems are used with double-leaf doors, it is important to ensure that a cushioned locking device is used for the active leaf, so that the forces are not transmitted to the hinges 1:1. In this case, SIMONSWERK recommends using a third hinge in the upper third of the door (see "4. Third hinge").

Load values for hinges

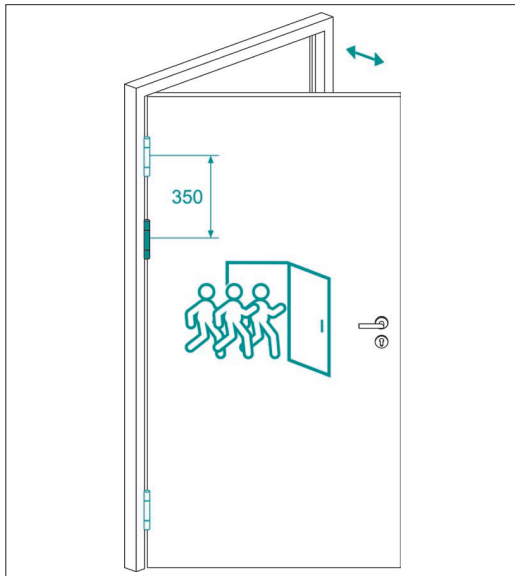

7. High frequency

For doors that are subject to high traffic, SIMONSWERK recommends setting the hinges in pairs at the top. In this case, SIMONSWERK recommends placing a hinge in the upper third (see "4. Third hinge").

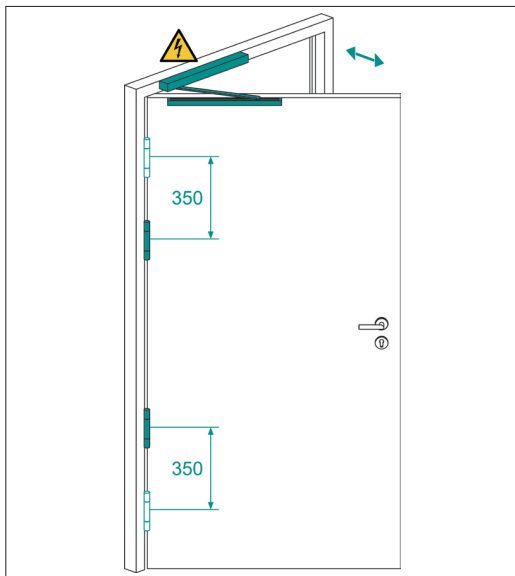

8. Door drives

When a swing-door operator is used, SIMONSWERK recommends using a total of four hinges, placed in two pairs at the top and the bottom. The international distance between a pair of hinges should not exceed 350 mm (see "4. Third hinge").

Load values for hinges

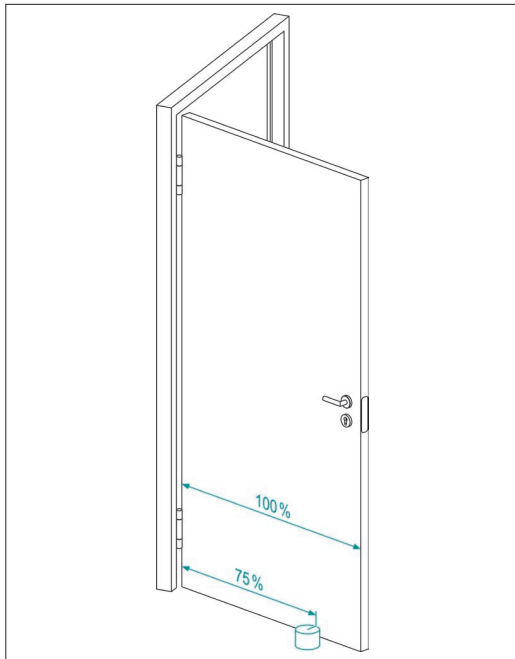

9. Door stops

If it is necessary to use a door stop, this should either be mounted on the wall or, instead, on the floor placed at 75 % of the door's width away from the hinge axis in the direction of the lock.

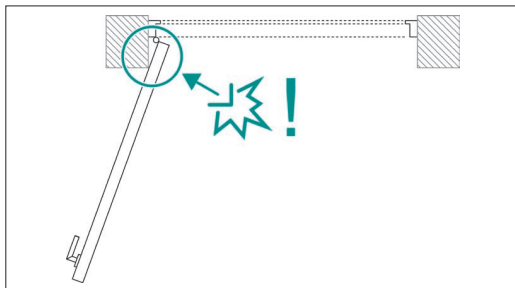

10. Wall openings

Factors such as Door stops, projecting wall openings or similar cannot be measured or estimated and need to be considered individually, due to the lever action and forces that may occur if the door is opened too far beyond a defined level. As a result of the doors' masses/weights, this can quickly lead to damage to the fastening, the hinges or similar.

Load values for hinges

1.1. Floor sealing

When using a floor seal, make sure that it is properly adjusted to avoid unnecessary additional loads on the bottom hinge. In particular, bruises due to the “trigger” in the rebate area, as well as disproportionately strong pressure of the seal to the floor, must be avoided at all costs.

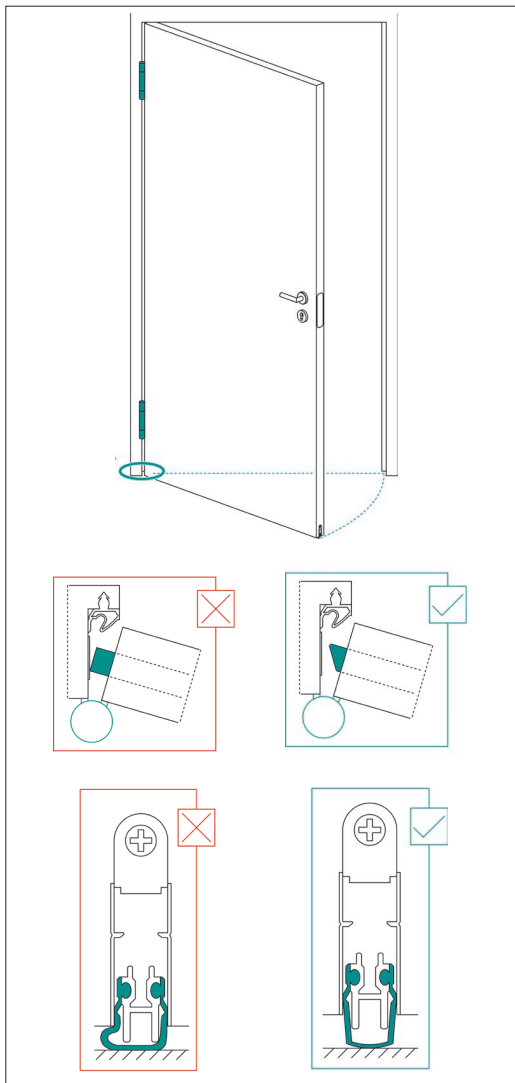

Load values for hinges

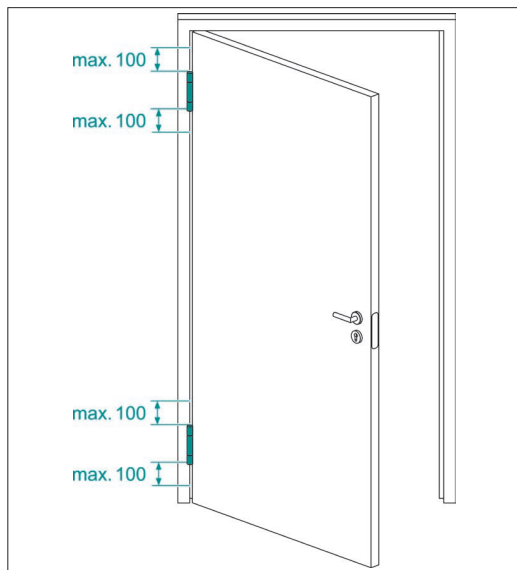

12. Frame fixing

To achieve a max. load capacity of a door hinge a proper and appropriate assembly of all components is compulsory. Special emphasis shall be given to the fixing of the door element to the wall. Especially closed frames, whether made of steel, aluminium or derived timber boards, often show a higher instability, therefore it is necessary to pay attention to a secure fixing to the brickwork or framework. Foaming alone in this area is not recommended for door weights > 40 kg. Here, a force-fitted connection must be created via a screw or plug connection through the receiver, or max. 100 mm from the other edge of the hinges.

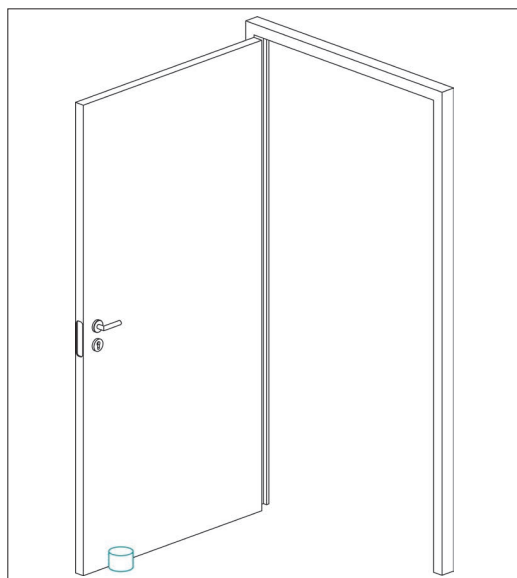

13. Rest position

SIMONSWERK door hinges of the latest design are provided with high-quality maintenance-free slide bearings. The used bearing technology meets the requirements for maintenance-free, durability and ease of movement to the highest level. The last point in particular can cause the door to move automatically, depending on the installation situation, structure and weight of the door leaf. Especially with multi-axis door hinges (e.g. TECTUS), a rest position - e.g. at 90° or 180° - cannot be guaranteed permanently.

Load values for hinges

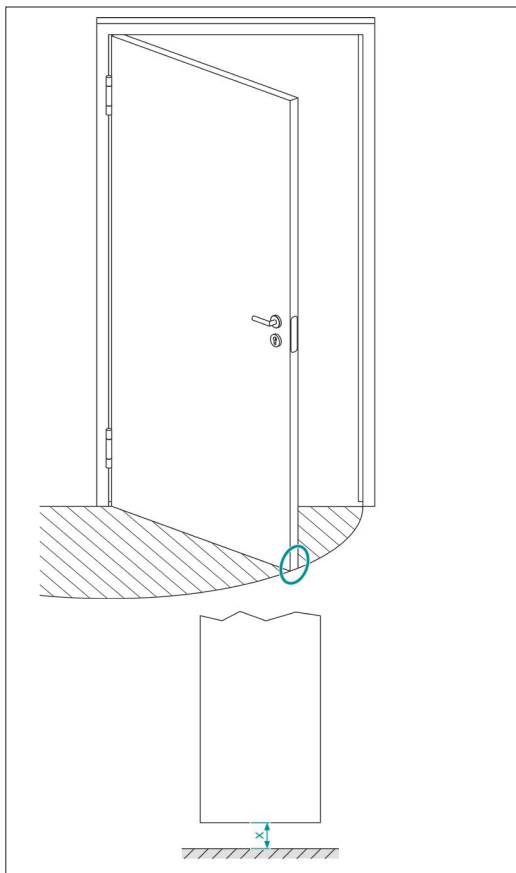

14. Floor air

There must be sufficient floor air over the entire opening angle of the door. For interior doors, SIMONSWERK recommends a distance of 7 mm as the nominal dimension for the bottom air gap. In the case of uneven or rising floors, it may be necessary to adjust the floor air accordingly. A slight sagging of the door over the entire opening angle is considered normal from a technical point of view, depending on the door width, door weight, etc.

15. Miscellaneous

The points given here are simply guidelines. In practice, it may very well make sense, depending on the door's composition, usage levels, location, etc., to take the above factors into account even for door widths ≤ 1000 mm. This needs to be decided on a case-by-case basis. In any case, care must be taken to ensure that the hinges are of a sufficient size to be able to cover the extraneous factors.

SIMONSWERK GmbH

Bosfelder Weg 5
33378 Rheda-Wiedenbrück
Germany

☎ +49 (0)5242/413 - 0
✉ info@simonswerk.de

www.simonswerk.com

Member of the
**SIMONSWERK
GROUP**