

SIMONSWERK

Anselmi & C. S.r.l.
Via Ca' Morelli, 19
31056 Roncade (TV)
Italy
+39 0422 707426
www.anselmisrl.it

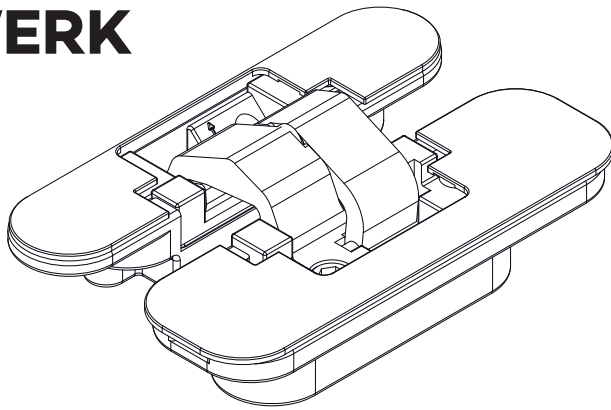

AN 150 3D 44
AN 170 3D 44

DIT_SP_020 rev.4 13/09/2023

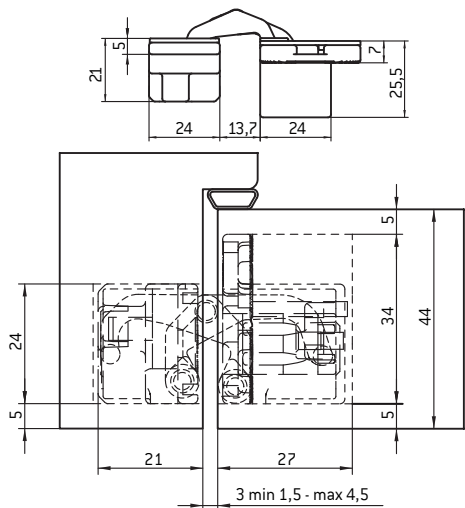
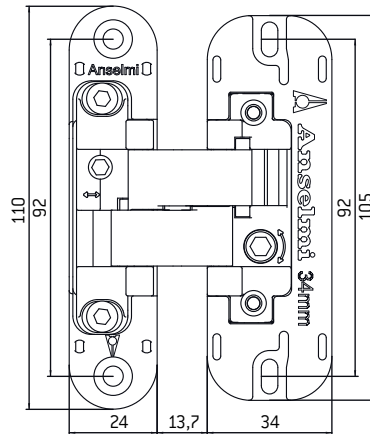

FRESATURE MILLING

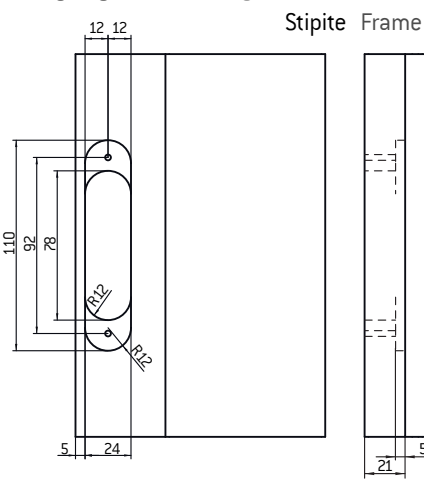

ISTRUZIONI REGOLAZIONE Adjustment Instructions

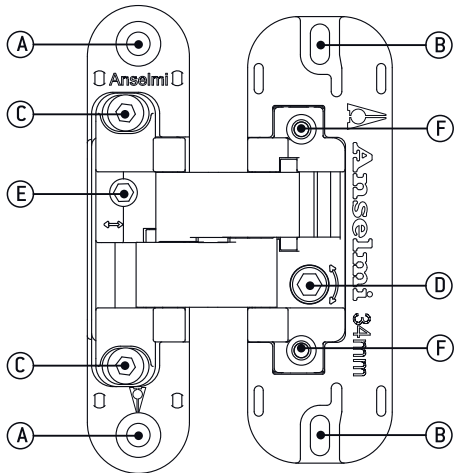

A Foro viti di fissaggio della cerniera allo stipite.
Fixing hole for the hinge to the frame.

B Fori asolati per regolazione verticale e fissaggio alla porta.
Oval holes for vertical adjustment and fixing to the door.

C Vite di fissaggio regolazione profondità.
Fixing screw of depth adjustment.

D Vite autobloccante per regolazione laterale.
Self-locking screw for lateral adjustment.

E Eccentrico per regolazione profondità.
Excentric system for depth adjustment.

F Vite opzionale D.3,5 mm per fissaggio verticale porta.
Optional D.3,5 mm screw for vertical fixing of the door.

Regolazione Altezza Height Adjustment

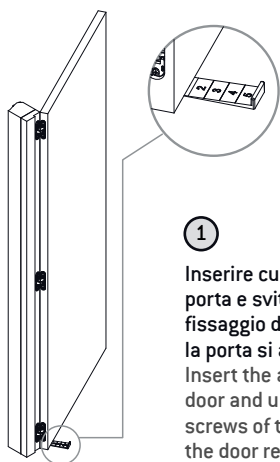

1
Inserire cuneo di regolazione sotto la porta e svitare di un giro le viti di fissaggio della cerniera sulla porta; la porta si appoggia sul cuneo.
Insert the adjustment wedge under the door and unscrew one turn the fixing screws of the hinge on the door; the door rests on the wedge.

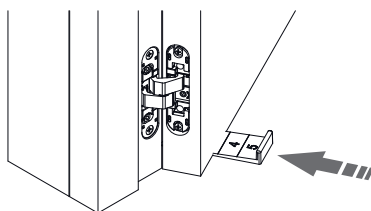

2
Spingere il cuneo sotto la porta sino a raggiungere la luce da terra desiderata; bloccare nuovamente le viti.
Slide the wedge under the door until achieve the desired measure from the ground; re-lock the screws.

Opzionale Optional

Avvitare la vite aggiuntiva D. 3,5 mm per bloccaggio verticale fino al fermo ed estrarre il cuneo di regolazione.
Screw in the optional screw D. 3.5 mm for vertical fixing up to the stopper and pull the adjustment wedge.

Regolazione Profondità Depth Adjustment

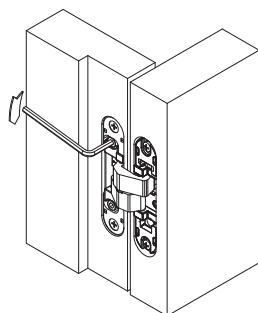

1

Svitare le viti C di un giro.
Unscrew the C screws one turn.

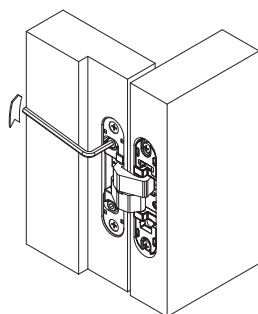

3

Fissare entrambe le viti C.
Fix the two C screws.

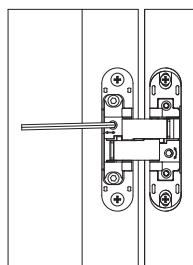

2

Agendo sull'eccentrico E in senso orario la porta trasla di - 1 mm.
Acting on the eccentric E clockwise the door moves to - 1 mm.

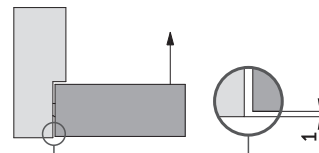

2

Agendo sull'eccentrico E in senso antiorario la porta trasla di + 1 mm.
Acting on the eccentric E counterclockwise the door moves to + 1 mm.

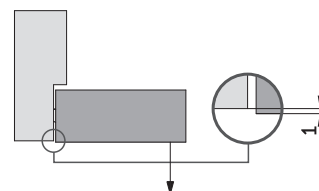

Regolazione Laterale Side Adjustment

1

Agire sulla vite D.
Act on D screw.

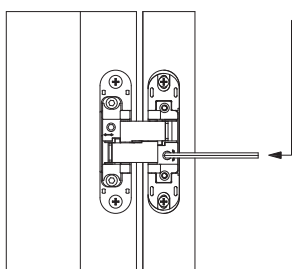

2

Agendo sulla vite D in senso orario la porta trasla di - 1,5 mm.
Acting on the D screw clockwise the door moves to - 1,5 mm.

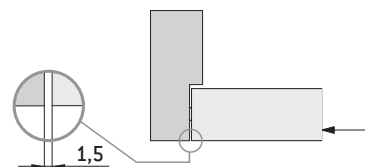

2

Agendo sulla vite D in senso antiorario la porta trasla di + 1,5 mm.
Acting on the D screw counterclockwise the door moves to + 1,5 mm.

